









Miniature Series

HiBD125 / 10kA 125AF 63-125A

<p>Standard Protection Specification</p> <p>IEC/EN60947-2 overload, short-circuit 10kA at AC240/415V - AC240V (1P, 1P+N), AC240/415V - Ics = 75% Icu</p> <p>63, 80, 100, 125A 1, 2, 3, 4, 1+N, 3+N pole B, C, D curve</p> <p>Accessory</p> <p>auxiliary switch, trip alarm switch, auxiliary & trip alarm switch, shunt trip, shunt trip & auxiliary switch, under voltage trip</p>	<p>Dimensions</p>
---	--------------------------

■ Order information

HiBD125

Rating	Code			Unit (EA)	Category		
	B curve	C curve	D curve				
 10kA, 1P	63A	HiBD125 1PMBS0000C 00063	HiBD125 1PMCS0000C 00063	HiBD125 1PMDS0000C 00063	80	MCB	M7
	80A	HiBD125 1PMBS0000C 00080	HiBD125 1PMCS0000C 00080	HiBD125 1PMDS0000C 00080			
	100A	HiBD125 1PMBS0000C 00100	HiBD125 1PMCS0000C 00100	HiBD125 1PMDS0000C 00100			
	125A	HiBD125 1PMBS0000C 00125	HiBD125 1PMCS0000C 00125	HiBD125 1PMDS0000C 00125			
 10kA, 2P	63A	HiBD125 2PMBS0000C 00063	HiBD125 2PMCS0000C 00063	HiBD125 2PMDS0000C 00063	40	MCB	M7
	80A	HiBD125 2PMBS0000C 00080	HiBD125 2PMCS0000C 00080	HiBD125 2PMDS0000C 00080			
	100A	HiBD125 2PMBS0000C 00100	HiBD125 2PMCS0000C 00100	HiBD125 2PMDS0000C 00100			
	125A	HiBD125 2PMBS0000C 00125	HiBD125 2PMCS0000C 00125	HiBD125 2PMDS0000C 00125			
 10kA, 3P	63A	HiBD125 3PMBS0000C 00063	HiBD125 3PMCS0000C 00063	HiBD125 3PMDS0000C 00063	20	MCB	M7
	80A	HiBD125 3PMBS0000C 00080	HiBD125 3PMCS0000C 00080	HiBD125 3PMDS0000C 00080			
	100A	HiBD125 3PMBS0000C 00100	HiBD125 3PMCS0000C 00100	HiBD125 3PMDS0000C 00100			
	125A	HiBD125 3PMBS0000C 00125	HiBD125 3PMCS0000C 00125	HiBD125 3PMDS0000C 00125			
 10kA, 4P	63A	HiBD125 4PMBS0000C 00063	HiBD125 4PMCS0000C 00063	HiBD125 4PMDS0000C 00063	20	MCB	M7
	80A	HiBD125 4PMBS0000C 00080	HiBD125 4PMCS0000C 00080	HiBD125 4PMDS0000C 00080			
	100A	HiBD125 4PMBS0000C 00100	HiBD125 4PMCS0000C 00100	HiBD125 4PMDS0000C 00100			
	125A	HiBD125 4PMBS0000C 00125	HiBD125 4PMCS0000C 00125	HiBD125 4PMDS0000C 00125			
 10kA, 1P+N	63A	HiBD125 1NMBS0000C 00063	HiBD125 1NMCS0000C 00063	HiBD125 1NMDS0000C 00063	40	MCB	M7
	80A	HiBD125 1NMBS0000C 00080	HiBD125 1NMCS0000C 00080	HiBD125 1NMDS0000C 00080			
	100A	HiBD125 1NMBS0000C 00100	HiBD125 1NMCS0000C 00100	HiBD125 1NMDS0000C 00100			
	125A	HiBD125 1NMBS0000C 00125	HiBD125 1NMCS0000C 00125	HiBD125 1NMDS0000C 00125			
 10kA, 3P+N	63A	HiBD125 3NMBS0000C 00063	HiBD125 3NMCS0000C 00063	HiBD125 3NMDS0000C 00063	20	MCB	M7
	80A	HiBD125 3NMBS0000C 00080	HiBD125 3NMCS0000C 00080	HiBD125 3NMDS0000C 00080			
	100A	HiBD125 3NMBS0000C 00100	HiBD125 3NMCS0000C 00100	HiBD125 3NMDS0000C 00100			
	125A	HiBD125 3NMBS0000C 00125	HiBD125 3NMCS0000C 00125	HiBD125 3NMDS0000C 00125			



HiBD63h / 10kA 63AF 1-63A

MCB

<p>Standard Protection Specification</p>	<p>IEC/EN60898 overload, short-circuit 10kA at AC240/415V - AC240V (1P, 1P+N), AC240/415V - Ics = 75% Icu 1, 2, 3, 4, 5, 6, 10, 13, 15, 16, 20, 25, 32, 40, 50, 63A 1, 2, 3, 4, 1+N, 3+N pole B, C, D curve</p>	<p>Dimensions</p>
<p>Accessory</p>	<p>auxiliary switch, trip alarm switch, auxiliary & trip alarm switch, shunt trip, shunt trip & auxiliary switch, under voltage trip</p>	

Order information



HiBD63h

Rating	Code			Unit (EA)	Category		
	B curve	C curve	D curve				
 10kA, 1P	1A	HIBD63H 1PMBS0000C 00001	HIBD63H 1PMCS0000C 00001	HIBD63H 1PMDS0000C 00001	120	MCB	M7
	2A	HIBD63H 1PMBS0000C 00002	HIBD63H 1PMCS0000C 00002	HIBD63H 1PMDS0000C 00002			
	3A	HIBD63H 1PMBS0000C 00003	HIBD63H 1PMCS0000C 00003	HIBD63H 1PMDS0000C 00003			
	4A	HIBD63H 1PMBS0000C 00004	HIBD63H 1PMCS0000C 00004	HIBD63H 1PMDS0000C 00004			
	5A	HIBD63H 1PMBS0000C 00005	HIBD63H 1PMCS0000C 00005	HIBD63H 1PMDS0000C 00005			
	6A	HIBD63H 1PMBS0000C 00006	HIBD63H 1PMCS0000C 00006	HIBD63H 1PMDS0000C 00006			
	10A	HIBD63H 1PMBS0000C 00010	HIBD63H 1PMCS0000C 00010	HIBD63H 1PMDS0000C 00010			
	13A	HIBD63H 1PMBS0000C 00013	HIBD63H 1PMCS0000C 00013	HIBD63H 1PMDS0000C 00013			
	15A	HIBD63H 1PMBS0000C 00015	HIBD63H 1PMCS0000C 00015	HIBD63H 1PMDS0000C 00015			
	16A	HIBD63H 1PMBS0000C 00016	HIBD63H 1PMCS0000C 00016	HIBD63H 1PMDS0000C 00016			
	20A	HIBD63H 1PMBS0000C 00020	HIBD63H 1PMCS0000C 00020	HIBD63H 1PMDS0000C 00020			
	25A	HIBD63H 1PMBS0000C 00025	HIBD63H 1PMCS0000C 00025	HIBD63H 1PMDS0000C 00025			
	32A	HIBD63H 1PMBS0000C 00032	HIBD63H 1PMCS0000C 00032	HIBD63H 1PMDS0000C 00032			
	40A	HIBD63H 1PMBS0000C 00040	HIBD63H 1PMCS0000C 00040	HIBD63H 1PMDS0000C 00040			
50A	HIBD63H 1PMBS0000C 00050	HIBD63H 1PMCS0000C 00050	HIBD63H 1PMDS0000C 00050				
63A	HIBD63H 1PMBS0000C 00063	HIBD63H 1PMCS0000C 00063	HIBD63H 1PMDS0000C 00063				
 10kA, 2P	1A	HIBD63H 2PMBS0000C 00001	HIBD63H 2PMCS0000C 00001	HIBD63H 2PMDS0000C 00001	60	MCB	M7
	2A	HIBD63H 2PMBS0000C 00002	HIBD63H 2PMCS0000C 00002	HIBD63H 2PMDS0000C 00002			
	3A	HIBD63H 2PMBS0000C 00003	HIBD63H 2PMCS0000C 00003	HIBD63H 2PMDS0000C 00003			
	4A	HIBD63H 2PMBS0000C 00004	HIBD63H 2PMCS0000C 00004	HIBD63H 2PMDS0000C 00004			
	5A	HIBD63H 2PMBS0000C 00005	HIBD63H 2PMCS0000C 00005	HIBD63H 2PMDS0000C 00005			
	6A	HIBD63H 2PMBS0000C 00006	HIBD63H 2PMCS0000C 00006	HIBD63H 2PMDS0000C 00006			
	10A	HIBD63H 2PMBS0000C 00010	HIBD63H 2PMCS0000C 00010	HIBD63H 2PMDS0000C 00010			
	13A	HIBD63H 2PMBS0000C 00013	HIBD63H 2PMCS0000C 00013	HIBD63H 2PMDS0000C 00013			
	15A	HIBD63H 2PMBS0000C 00015	HIBD63H 2PMCS0000C 00015	HIBD63H 2PMDS0000C 00015			
	16A	HIBD63H 2PMBS0000C 00016	HIBD63H 2PMCS0000C 00016	HIBD63H 2PMDS0000C 00016			
	20A	HIBD63H 2PMBS0000C 00020	HIBD63H 2PMCS0000C 00020	HIBD63H 2PMDS0000C 00020			
	25A	HIBD63H 2PMBS0000C 00025	HIBD63H 2PMCS0000C 00025	HIBD63H 2PMDS0000C 00025			
	32A	HIBD63H 2PMBS0000C 00032	HIBD63H 2PMCS0000C 00032	HIBD63H 2PMDS0000C 00032			
	40A	HIBD63H 2PMBS0000C 00040	HIBD63H 2PMCS0000C 00040	HIBD63H 2PMDS0000C 00040			
50A	HIBD63H 2PMBS0000C 00050	HIBD63H 2PMCS0000C 00050	HIBD63H 2PMDS0000C 00050				
63A	HIBD63H 2PMBS0000C 00063	HIBD63H 2PMCS0000C 00063	HIBD63H 2PMDS0000C 00063				

HiBD63h / 10kA 63AF 1-63A

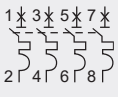

Order information

HiBD63h

Rating	Code			Unit (EA)	Category		
	B curve	C curve	D curve		MCB	M7	
  10kA, 3P	1A	HIBD63H 3PMBS0000C 00001	HIBD63H 3PMCS0000C 00001	HIBD63H 3PMDS0000C 00001	40	MCB	M7
	2A	HIBD63H 3PMBS0000C 00002	HIBD63H 3PMCS0000C 00002	HIBD63H 3PMDS0000C 00002			
	3A	HIBD63H 3PMBS0000C 00003	HIBD63H 3PMCS0000C 00003	HIBD63H 3PMDS0000C 00003			
	4A	HIBD63H 3PMBS0000C 00004	HIBD63H 3PMCS0000C 00004	HIBD63H 3PMDS0000C 00004			
	5A	HIBD63H 3PMBS0000C 00005	HIBD63H 3PMCS0000C 00005	HIBD63H 3PMDS0000C 00005			
	6A	HIBD63H 3PMBS0000C 00006	HIBD63H 3PMCS0000C 00006	HIBD63H 3PMDS0000C 00006			
	10A	HIBD63H 3PMBS0000C 00010	HIBD63H 3PMCS0000C 00010	HIBD63H 3PMDS0000C 00010			
	13A	HIBD63H 3PMBS0000C 00013	HIBD63H 3PMCS0000C 00013	HIBD63H 3PMDS0000C 00013			
	15A	HIBD63H 3PMBS0000C 00015	HIBD63H 3PMCS0000C 00015	HIBD63H 3PMDS0000C 00015			
	16A	HIBD63H 3PMBS0000C 00016	HIBD63H 3PMCS0000C 00016	HIBD63H 3PMDS0000C 00016			
	20A	HIBD63H 3PMBS0000C 00020	HIBD63H 3PMCS0000C 00020	HIBD63H 3PMDS0000C 00020			
	25A	HIBD63H 3PMBS0000C 00025	HIBD63H 3PMCS0000C 00025	HIBD63H 3PMDS0000C 00025			
	32A	HIBD63H 3PMBS0000C 00032	HIBD63H 3PMCS0000C 00032	HIBD63H 3PMDS0000C 00032			
	40A	HIBD63H 3PMBS0000C 00040	HIBD63H 3PMCS0000C 00040	HIBD63H 3PMDS0000C 00040			
50A	HIBD63H 3PMBS0000C 00050	HIBD63H 3PMCS0000C 00050	HIBD63H 3PMDS0000C 00050				
63A	HIBD63H 3PMBS0000C 00063	HIBD63H 3PMCS0000C 00063	HIBD63H 3PMDS0000C 00063				
  10kA, 4P	1A	HIBD63H 4PMBS0000C 00001	HIBD63H 4PMCS0000C 00001	HIBD63H 4PMDS0000C 00001	30	MCB	M7
	2A	HIBD63H 4PMBS0000C 00002	HIBD63H 4PMCS0000C 00002	HIBD63H 4PMDS0000C 00002			
	3A	HIBD63H 4PMBS0000C 00003	HIBD63H 4PMCS0000C 00003	HIBD63H 4PMDS0000C 00003			
	4A	HIBD63H 4PMBS0000C 00004	HIBD63H 4PMCS0000C 00004	HIBD63H 4PMDS0000C 00004			
	5A	HIBD63H 4PMBS0000C 00005	HIBD63H 4PMCS0000C 00005	HIBD63H 4PMDS0000C 00005			
	6A	HIBD63H 4PMBS0000C 00006	HIBD63H 4PMCS0000C 00006	HIBD63H 4PMDS0000C 00006			
	10A	HIBD63H 4PMBS0000C 00010	HIBD63H 4PMCS0000C 00010	HIBD63H 4PMDS0000C 00010			
	13A	HIBD63H 4PMBS0000C 00013	HIBD63H 4PMCS0000C 00013	HIBD63H 4PMDS0000C 00013			
	15A	HIBD63H 4PMBS0000C 00015	HIBD63H 4PMCS0000C 00015	HIBD63H 4PMDS0000C 00015			
	16A	HIBD63H 4PMBS0000C 00016	HIBD63H 4PMCS0000C 00016	HIBD63H 4PMDS0000C 00016			
	20A	HIBD63H 4PMBS0000C 00020	HIBD63H 4PMCS0000C 00020	HIBD63H 4PMDS0000C 00020			
	25A	HIBD63H 4PMBS0000C 00025	HIBD63H 4PMCS0000C 00025	HIBD63H 4PMDS0000C 00025			
	32A	HIBD63H 4PMBS0000C 00032	HIBD63H 4PMCS0000C 00032	HIBD63H 4PMDS0000C 00032			
	40A	HIBD63H 4PMBS0000C 00040	HIBD63H 4PMCS0000C 00040	HIBD63H 4PMDS0000C 00040			
50A	HIBD63H 4PMBS0000C 00050	HIBD63H 4PMCS0000C 00050	HIBD63H 4PMDS0000C 00050				
63A	HIBD63H 4PMBS0000C 00063	HIBD63H 4PMCS0000C 00063	HIBD63H 4PMDS0000C 00063				

Order information

HiBD63h

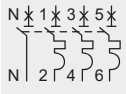

Rating	Code			Unit (EA)	Category		
	B curve	C curve	D curve				
  10kA, 1P+N	1A	HIBD63H 1NMBS0000C 00001	HIBD63H 1NMCS0000C 00001	HIBD63H 1NMDS0000C 00001	60	MCB	M7
	2A	HIBD63H 1NMBS0000C 00002	HIBD63H 1NMCS0000C 00002	HIBD63H 1NMDS0000C 00002			
	3A	HIBD63H 1NMBS0000C 00003	HIBD63H 1NMCS0000C 00003	HIBD63H 1NMDS0000C 00003			
	4A	HIBD63H 1NMBS0000C 00004	HIBD63H 1NMCS0000C 00004	HIBD63H 1NMDS0000C 00004			
	5A	HIBD63H 1NMBS0000C 00005	HIBD63H 1NMCS0000C 00005	HIBD63H 1NMDS0000C 00005			
	6A	HIBD63H 1NMBS0000C 00006	HIBD63H 1NMCS0000C 00006	HIBD63H 1NMDS0000C 00006			
	10A	HIBD63H 1NMBS0000C 00010	HIBD63H 1NMCS0000C 00010	HIBD63H 1NMDS0000C 00010			
	13A	HIBD63H 1NMBS0000C 00013	HIBD63H 1NMCS0000C 00013	HIBD63H 1NMDS0000C 00013			
	15A	HIBD63H 1NMBS0000C 00015	HIBD63H 1NMCS0000C 00015	HIBD63H 1NMDS0000C 00015			
	16A	HIBD63H 1NMBS0000C 00016	HIBD63H 1NMCS0000C 00016	HIBD63H 1NMDS0000C 00016			
	20A	HIBD63H 1NMBS0000C 00020	HIBD63H 1NMCS0000C 00020	HIBD63H 1NMDS0000C 00020			
	25A	HIBD63H 1NMBS0000C 00025	HIBD63H 1NMCS0000C 00025	HIBD63H 1NMDS0000C 00025			
	32A	HIBD63H 1NMBS0000C 00032	HIBD63H 1NMCS0000C 00032	HIBD63H 1NMDS0000C 00032			
	40A	HIBD63H 1NMBS0000C 00040	HIBD63H 1NMCS0000C 00040	HIBD63H 1NMDS0000C 00040			
50A	HIBD63H 1NMBS0000C 00050	HIBD63H 1NMCS0000C 00050	HIBD63H 1NMDS0000C 00050				
63A	HIBD63H 1NMBS0000C 00063	HIBD63H 1NMCS0000C 00063	HIBD63H 1NMDS0000C 00063				
  10kA, 3P+N	1A	HIBD63H 3NMBS0000C 00001	HIBD63H 3NMCS0000C 00001	HIBD63H 3NMDS0000C 00001	30	MCB	M7
	2A	HIBD63H 3NMBS0000C 00002	HIBD63H 3NMCS0000C 00002	HIBD63H 3NMDS0000C 00002			
	3A	HIBD63H 3NMBS0000C 00003	HIBD63H 3NMCS0000C 00003	HIBD63H 3NMDS0000C 00003			
	4A	HIBD63H 3NMBS0000C 00004	HIBD63H 3NMCS0000C 00004	HIBD63H 3NMDS0000C 00004			
	5A	HIBD63H 3NMBS0000C 00005	HIBD63H 3NMCS0000C 00005	HIBD63H 3NMDS0000C 00005			
	6A	HIBD63H 3NMBS0000C 00006	HIBD63H 3NMCS0000C 00006	HIBD63H 3NMDS0000C 00006			
	10A	HIBD63H 3NMBS0000C 00010	HIBD63H 3NMCS0000C 00010	HIBD63H 3NMDS0000C 00010			
	13A	HIBD63H 3NMBS0000C 00013	HIBD63H 3NMCS0000C 00013	HIBD63H 3NMDS0000C 00013			
	15A	HIBD63H 3NMBS0000C 00015	HIBD63H 3NMCS0000C 00015	HIBD63H 3NMDS0000C 00015			
	16A	HIBD63H 3NMBS0000C 00016	HIBD63H 3NMCS0000C 00016	HIBD63H 3NMDS0000C 00016			
	20A	HIBD63H 3NMBS0000C 00020	HIBD63H 3NMCS0000C 00020	HIBD63H 3NMDS0000C 00020			
	25A	HIBD63H 3NMBS0000C 00025	HIBD63H 3NMCS0000C 00025	HIBD63H 3NMDS0000C 00025			
	32A	HIBD63H 3NMBS0000C 00032	HIBD63H 3NMCS0000C 00032	HIBD63H 3NMDS0000C 00032			
	40A	HIBD63H 3NMBS0000C 00040	HIBD63H 3NMCS0000C 00040	HIBD63H 3NMDS0000C 00040			
50A	HIBD63H 3NMBS0000C 00050	HIBD63H 3NMCS0000C 00050	HIBD63H 3NMDS0000C 00050				
63A	HIBD63H 3NMBS0000C 00063	HIBD63H 3NMCS0000C 00063	HIBD63H 3NMDS0000C 00063				

MCB

HiBD63-N / 6kA 1-63A

Standard Protection Specification	IEC/EN60898 overload, short-circuit 6kA at AC240/415V - AC240V (1P, 1P+N), AC240/415V - Ics = 100% Icu 1, 2, 3, 4, 5, 6, 10, 13, 15, 16, 20, 25, 32, 40, 50, 63A 1, 2, 3, 4, 1+N, 3+N pole B, C, D curve
Accessory	auxiliary switch, trip alarm switch, auxiliary & trip alarm switch, shunt trip, shunt trip & auxiliary switch, under voltage trip

Order information



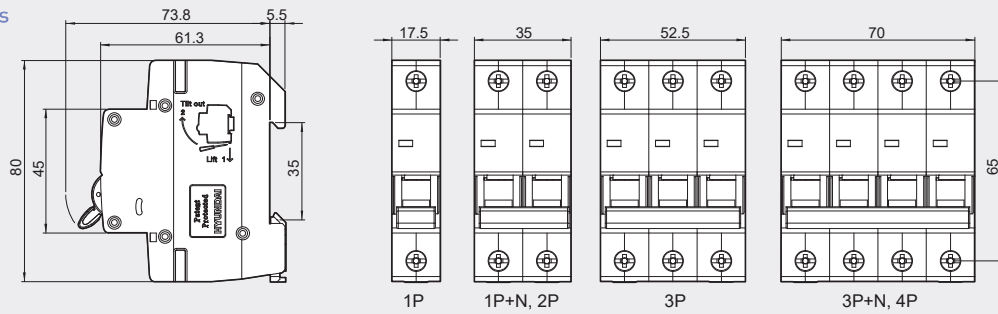

Rating	Code			Unit (EA)	Category		
	B curve	C curve	D curve		MCB	M7	
 1P 6kA, 1P	1A	HiBD63-N 1PMBS0000C 00001	HiBD63-N 1PMCS0000C 00001	HiBD63-N 1PMDS0000C 00001	120	MCB	M7
	2A	HiBD63-N 1PMBS0000C 00002	HiBD63-N 1PMCS0000C 00002	HiBD63-N 1PMDS0000C 00002			
	3A	HiBD63-N 1PMBS0000C 00003	HiBD63-N 1PMCS0000C 00003	HiBD63-N 1PMDS0000C 00003			
	4A	HiBD63-N 1PMBS0000C 00004	HiBD63-N 1PMCS0000C 00004	HiBD63-N 1PMDS0000C 00004			
	5A	HiBD63-N 1PMBS0000C 00005	HiBD63-N 1PMCS0000C 00005	HiBD63-N 1PMDS0000C 00005			
	6A	HiBD63-N 1PMBS0000C 00006	HiBD63-N 1PMCS0000C 00006	HiBD63-N 1PMDS0000C 00006			
	10A	HiBD63-N 1PMBS0000C 00010	HiBD63-N 1PMCS0000C 00010	HiBD63-N 1PMDS0000C 00010			
	13A	HiBD63-N 1PMBS0000C 00013	HiBD63-N 1PMCS0000C 00013	HiBD63-N 1PMDS0000C 00013			
	15A	HiBD63-N 1PMBS0000C 00015	HiBD63-N 1PMCS0000C 00015	HiBD63-N 1PMDS0000C 00015			
	16A	HiBD63-N 1PMBS0000C 00016	HiBD63-N 1PMCS0000C 00016	HiBD63-N 1PMDS0000C 00016			
	20A	HiBD63-N 1PMBS0000C 00020	HiBD63-N 1PMCS0000C 00020	HiBD63-N 1PMDS0000C 00020			
	25A	HiBD63-N 1PMBS0000C 00025	HiBD63-N 1PMCS0000C 00025	HiBD63-N 1PMDS0000C 00025			
	32A	HiBD63-N 1PMBS0000C 00032	HiBD63-N 1PMCS0000C 00032	HiBD63-N 1PMDS0000C 00032			
	40A	HiBD63-N 1PMBS0000C 00040	HiBD63-N 1PMCS0000C 00040	HiBD63-N 1PMDS0000C 00040			
	50A	HiBD63-N 1PMBS0000C 00050	HiBD63-N 1PMCS0000C 00050	HiBD63-N 1PMDS0000C 00050			
63A	HiBD63-N 1PMBS0000C 00063	HiBD63-N 1PMCS0000C 00063	HiBD63-N 1PMDS0000C 00063				
 1P 3P 2P 4P 6kA, 2P	1A	HiBD63-N 2PMBS0000C 00001	HiBD63-N 2PMCS0000C 00001	HiBD63-N 2PMDS0000C 00001	60	MCB	M7
	2A	HiBD63-N 2PMBS0000C 00002	HiBD63-N 2PMCS0000C 00002	HiBD63-N 2PMDS0000C 00002			
	3A	HiBD63-N 2PMBS0000C 00003	HiBD63-N 2PMCS0000C 00003	HiBD63-N 2PMDS0000C 00003			
	4A	HiBD63-N 2PMBS0000C 00004	HiBD63-N 2PMCS0000C 00004	HiBD63-N 2PMDS0000C 00004			
	5A	HiBD63-N 2PMBS0000C 00005	HiBD63-N 2PMCS0000C 00005	HiBD63-N 2PMDS0000C 00005			
	6A	HiBD63-N 2PMBS0000C 00006	HiBD63-N 2PMCS0000C 00006	HiBD63-N 2PMDS0000C 00006			
	10A	HiBD63-N 2PMBS0000C 00010	HiBD63-N 2PMCS0000C 00010	HiBD63-N 2PMDS0000C 00010			
	13A	HiBD63-N 2PMBS0000C 00013	HiBD63-N 2PMCS0000C 00013	HiBD63-N 2PMDS0000C 00013			
	15A	HiBD63-N 2PMBS0000C 00015	HiBD63-N 2PMCS0000C 00015	HiBD63-N 2PMDS0000C 00015			
	16A	HiBD63-N 2PMBS0000C 00016	HiBD63-N 2PMCS0000C 00016	HiBD63-N 2PMDS0000C 00016			
	20A	HiBD63-N 2PMBS0000C 00020	HiBD63-N 2PMCS0000C 00020	HiBD63-N 2PMDS0000C 00020			
	25A	HiBD63-N 2PMBS0000C 00025	HiBD63-N 2PMCS0000C 00025	HiBD63-N 2PMDS0000C 00025			
	32A	HiBD63-N 2PMBS0000C 00032	HiBD63-N 2PMCS0000C 00032	HiBD63-N 2PMDS0000C 00032			
	40A	HiBD63-N 2PMBS0000C 00040	HiBD63-N 2PMCS0000C 00040	HiBD63-N 2PMDS0000C 00040			
	50A	HiBD63-N 2PMBS0000C 00050	HiBD63-N 2PMCS0000C 00050	HiBD63-N 2PMDS0000C 00050			
63A	HiBD63-N 2PMBS0000C 00063	HiBD63-N 2PMCS0000C 00063	HiBD63-N 2PMDS0000C 00063				

Dimensions



Order information



HiBD63-N

Rating	Code			Unit (EA)	Category						
	B curve	C curve	D curve		MCB	M7					
  6kA, 3P	1A	HIBD63-N 3PMBS0000C 00001	HIBD63-N 3PMCS0000C 00001	HIBD63-N 3PMDS0000C 00001	40	MCB	M7				
	2A	HIBD63-N 3PMBS0000C 00002	HIBD63-N 3PMCS0000C 00002	HIBD63-N 3PMDS0000C 00002							
	3A	HIBD63-N 3PMBS0000C 00003	HIBD63-N 3PMCS0000C 00003	HIBD63-N 3PMDS0000C 00003							
	4A	HIBD63-N 3PMBS0000C 00004	HIBD63-N 3PMCS0000C 00004	HIBD63-N 3PMDS0000C 00004							
	5A	HIBD63-N 3PMBS0000C 00005	HIBD63-N 3PMCS0000C 00005	HIBD63-N 3PMDS0000C 00005							
	6A	HIBD63-N 3PMBS0000C 00006	HIBD63-N 3PMCS0000C 00006	HIBD63-N 3PMDS0000C 00006							
	10A	HIBD63-N 3PMBS0000C 00010	HIBD63-N 3PMCS0000C 00010	HIBD63-N 3PMDS0000C 00010							
	13A	HIBD63-N 3PMBS0000C 00013	HIBD63-N 3PMCS0000C 00013	HIBD63-N 3PMDS0000C 00013							
	15A	HIBD63-N 3PMBS0000C 00015	HIBD63-N 3PMCS0000C 00015	HIBD63-N 3PMDS0000C 00015							
	16A	HIBD63-N 3PMBS0000C 00016	HIBD63-N 3PMCS0000C 00016	HIBD63-N 3PMDS0000C 00016							
	20A	HIBD63-N 3PMBS0000C 00020	HIBD63-N 3PMCS0000C 00020	HIBD63-N 3PMDS0000C 00020							
	25A	HIBD63-N 3PMBS0000C 00025	HIBD63-N 3PMCS0000C 00025	HIBD63-N 3PMDS0000C 00025							
	32A	HIBD63-N 3PMBS0000C 00032	HIBD63-N 3PMCS0000C 00032	HIBD63-N 3PMDS0000C 00032							
	40A	HIBD63-N 3PMBS0000C 00040	HIBD63-N 3PMCS0000C 00040	HIBD63-N 3PMDS0000C 00040							
	50A	HIBD63-N 3PMBS0000C 00050	HIBD63-N 3PMCS0000C 00050	HIBD63-N 3PMDS0000C 00050							
	63A	HIBD63-N 3PMBS0000C 00063	HIBD63-N 3PMCS0000C 00063	HIBD63-N 3PMDS0000C 00063							
	  6kA, 4P	1A	HIBD63-N 4PMBS0000C 00001	HIBD63-N 4PMCS0000C 00001				HIBD63-N 4PMDS0000C 00001	30	MCB	M7
		2A	HIBD63-N 4PMBS0000C 00002	HIBD63-N 4PMCS0000C 00002				HIBD63-N 4PMDS0000C 00002			
3A		HIBD63-N 4PMBS0000C 00003	HIBD63-N 4PMCS0000C 00003	HIBD63-N 4PMDS0000C 00003							
4A		HIBD63-N 4PMBS0000C 00004	HIBD63-N 4PMCS0000C 00004	HIBD63-N 4PMDS0000C 00004							
5A		HIBD63-N 4PMBS0000C 00005	HIBD63-N 4PMCS0000C 00005	HIBD63-N 4PMDS0000C 00005							
6A		HIBD63-N 4PMBS0000C 00006	HIBD63-N 4PMCS0000C 00006	HIBD63-N 4PMDS0000C 00006							
10A		HIBD63-N 4PMBS0000C 00010	HIBD63-N 4PMCS0000C 00010	HIBD63-N 4PMDS0000C 00010							
13A		HIBD63-N 4PMBS0000C 00013	HIBD63-N 4PMCS0000C 00013	HIBD63-N 4PMDS0000C 00013							
15A		HIBD63-N 4PMBS0000C 00015	HIBD63-N 4PMCS0000C 00015	HIBD63-N 4PMDS0000C 00015							
16A		HIBD63-N 4PMBS0000C 00016	HIBD63-N 4PMCS0000C 00016	HIBD63-N 4PMDS0000C 00016							
20A		HIBD63-N 4PMBS0000C 00020	HIBD63-N 4PMCS0000C 00020	HIBD63-N 4PMDS0000C 00020							
25A		HIBD63-N 4PMBS0000C 00025	HIBD63-N 4PMCS0000C 00025	HIBD63-N 4PMDS0000C 00025							
32A		HIBD63-N 4PMBS0000C 00032	HIBD63-N 4PMCS0000C 00032	HIBD63-N 4PMDS0000C 00032							
40A		HIBD63-N 4PMBS0000C 00040	HIBD63-N 4PMCS0000C 00040	HIBD63-N 4PMDS0000C 00040							
50A		HIBD63-N 4PMBS0000C 00050	HIBD63-N 4PMCS0000C 00050	HIBD63-N 4PMDS0000C 00050							
63A		HIBD63-N 4PMBS0000C 00063	HIBD63-N 4PMCS0000C 00063	HIBD63-N 4PMDS0000C 00063							

HiBD63-N / 6kA 1-63A

Order information

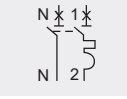
HiBD63-N

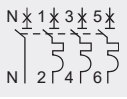

Rating	Code			Unit (EA)	Category		
	B curve	C curve	D curve		MCB	M7	
  6kA, 1P+N	1A	HiBD63-N 1NMB50000C 00001	HiBD63-N 1NMCS0000C 00001	HiBD63-N 1NMDS0000C 00001	60	MCB	M7
	2A	HiBD63-N 1NMB50000C 00002	HiBD63-N 1NMCS0000C 00002	HiBD63-N 1NMDS0000C 00002			
	3A	HiBD63-N 1NMB50000C 00003	HiBD63-N 1NMCS0000C 00003	HiBD63-N 1NMDS0000C 00003			
	4A	HiBD63-N 1NMB50000C 00004	HiBD63-N 1NMCS0000C 00004	HiBD63-N 1NMDS0000C 00004			
	5A	HiBD63-N 1NMB50000C 00005	HiBD63-N 1NMCS0000C 00005	HiBD63-N 1NMDS0000C 00005			
	6A	HiBD63-N 1NMB50000C 00006	HiBD63-N 1NMCS0000C 00006	HiBD63-N 1NMDS0000C 00006			
	10A	HiBD63-N 1NMB50000C 00010	HiBD63-N 1NMCS0000C 00010	HiBD63-N 1NMDS0000C 00010			
	13A	HiBD63-N 1NMB50000C 00013	HiBD63-N 1NMCS0000C 00013	HiBD63-N 1NMDS0000C 00013			
	15A	HiBD63-N 1NMB50000C 00015	HiBD63-N 1NMCS0000C 00015	HiBD63-N 1NMDS0000C 00015			
	16A	HiBD63-N 1NMB50000C 00016	HiBD63-N 1NMCS0000C 00016	HiBD63-N 1NMDS0000C 00016			
	20A	HiBD63-N 1NMB50000C 00020	HiBD63-N 1NMCS0000C 00020	HiBD63-N 1NMDS0000C 00020			
	25A	HiBD63-N 1NMB50000C 00025	HiBD63-N 1NMCS0000C 00025	HiBD63-N 1NMDS0000C 00025			
	32A	HiBD63-N 1NMB50000C 00032	HiBD63-N 1NMCS0000C 00032	HiBD63-N 1NMDS0000C 00032			
	40A	HiBD63-N 1NMB50000C 00040	HiBD63-N 1NMCS0000C 00040	HiBD63-N 1NMDS0000C 00040			
	50A	HiBD63-N 1NMB50000C 00050	HiBD63-N 1NMCS0000C 00050	HiBD63-N 1NMDS0000C 00050			
63A	HiBD63-N 1NMB50000C 00063	HiBD63-N 1NMCS0000C 00063	HiBD63-N 1NMDS0000C 00063				
  6kA, 3P+N	1A	HiBD63-N 3NMB50000C 00001	HiBD63-N 3NMCS0000C 00001	HiBD63-N 3NMDS0000C 00001	30	MCB	M7
	2A	HiBD63-N 3NMB50000C 00002	HiBD63-N 3NMCS0000C 00002	HiBD63-N 3NMDS0000C 00002			
	3A	HiBD63-N 3NMB50000C 00003	HiBD63-N 3NMCS0000C 00003	HiBD63-N 3NMDS0000C 00003			
	4A	HiBD63-N 3NMB50000C 00004	HiBD63-N 3NMCS0000C 00004	HiBD63-N 3NMDS0000C 00004			
	5A	HiBD63-N 3NMB50000C 00005	HiBD63-N 3NMCS0000C 00005	HiBD63-N 3NMDS0000C 00005			
	6A	HiBD63-N 3NMB50000C 00006	HiBD63-N 3NMCS0000C 00006	HiBD63-N 3NMDS0000C 00006			
	10A	HiBD63-N 3NMB50000C 00010	HiBD63-N 3NMCS0000C 00010	HiBD63-N 3NMDS0000C 00010			
	13A	HiBD63-N 3NMB50000C 00013	HiBD63-N 3NMCS0000C 00013	HiBD63-N 3NMDS0000C 00013			
	15A	HiBD63-N 3NMB50000C 00015	HiBD63-N 3NMCS0000C 00015	HiBD63-N 3NMDS0000C 00015			
	16A	HiBD63-N 3NMB50000C 00016	HiBD63-N 3NMCS0000C 00016	HiBD63-N 3NMDS0000C 00016			
	20A	HiBD63-N 3NMB50000C 00020	HiBD63-N 3NMCS0000C 00020	HiBD63-N 3NMDS0000C 00020			
	25A	HiBD63-N 3NMB50000C 00025	HiBD63-N 3NMCS0000C 00025	HiBD63-N 3NMDS0000C 00025			
	32A	HiBD63-N 3NMB50000C 00032	HiBD63-N 3NMCS0000C 00032	HiBD63-N 3NMDS0000C 00032			
	40A	HiBD63-N 3NMB50000C 00040	HiBD63-N 3NMCS0000C 00040	HiBD63-N 3NMDS0000C 00040			
	50A	HiBD63-N 3NMB50000C 00050	HiBD63-N 3NMCS0000C 00050	HiBD63-N 3NMDS0000C 00050			
63A	HiBD63-N 3NMB50000C 00063	HiBD63-N 3NMCS0000C 00063	HiBD63-N 3NMDS0000C 00063				

HiBD63-NS / 4.5/6kA 1 pole size 1P+N 1-40A

<p>Standard Protection Specification</p> <p>Accessory</p>	<p>IEC/EN60898 overload, short-circuit 4.5/6kA at AC240V - 4.5kA for 1-25A - 6kA for 32-40A - Ics = 100% Icu 1, 2, 3, 4, 5, 6, 10, 13, 15, 16, 20, 25, 32, 40A 1+N pole B, C curve auxiliary switch, trip alarm switch, auxiliary & trip alarm switch, shunt trip, shunt trip & auxiliary switch, under voltage trip</p>	<p>Dimensions</p>
---	---	--------------------------

MCB



■ Order information

Rating	Code		Unit (EA)	HiBD63-NS		
	B curve	C curve		Category		
  4.5/6kA, 1P+N	1A	HIBD63-NS 1NMBS0000C 00001	HIBD63-NS 1NMCS0000C 00001	120	MCB	M7
	2A	HIBD63-NS 1NMBS0000C 00002	HIBD63-NS 1NMCS0000C 00002			
	3A	HIBD63-NS 1NMBS0000C 00003	HIBD63-NS 1NMCS0000C 00003			
	4A	HIBD63-NS 1NMBS0000C 00004	HIBD63-NS 1NMCS0000C 00004			
	5A	HIBD63-NS 1NMBS0000C 00005	HIBD63-NS 1NMCS0000C 00005			
	6A	HIBD63-NS 1NMBS0000C 00006	HIBD63-NS 1NMCS0000C 00006			
	10A	HIBD63-NS 1NMBS0000C 00010	HIBD63-NS 1NMCS0000C 00010			
	13A	HIBD63-NS 1NMBS0000C 00013	HIBD63-NS 1NMCS0000C 00013			
	15A	HIBD63-NS 1NMBS0000C 00015	HIBD63-NS 1NMCS0000C 00015			
	16A	HIBD63-NS 1NMBS0000C 00016	HIBD63-NS 1NMCS0000C 00016			
	20A	HIBD63-NS 1NMBS0000C 00020	HIBD63-NS 1NMCS0000C 00020			
	25A	HIBD63-NS 1NMBS0000C 00025	HIBD63-NS 1NMCS0000C 00025			
	32A	HIBD63-NS 1NMBS0000C 00032	HIBD63-NS 1NMCS0000C 00032			
	40A	HIBD63-NS 1NMBS0000C 00040	HIBD63-NS 1NMCS0000C 00040			

HiBD63-S / 4.5kA 1-40A

Standard Protection Specification	IEC/EN60898 overload, short-circuit 4.5kA at AC240/415V - AC240V (1P), AC240/415V - Ics = 100% Icu 1, 2, 3, 4, 5, 6, 10, 13, 15, 16, 20, 25, 32, 40A 1, 2, 3, 4 pole B, C curve
Accessory	auxiliary switch, trip alarm switch, auxiliary & trip alarm switch, shunt trip, shunt trip & auxiliary switch, under voltage trip

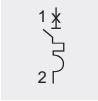
■ Order information

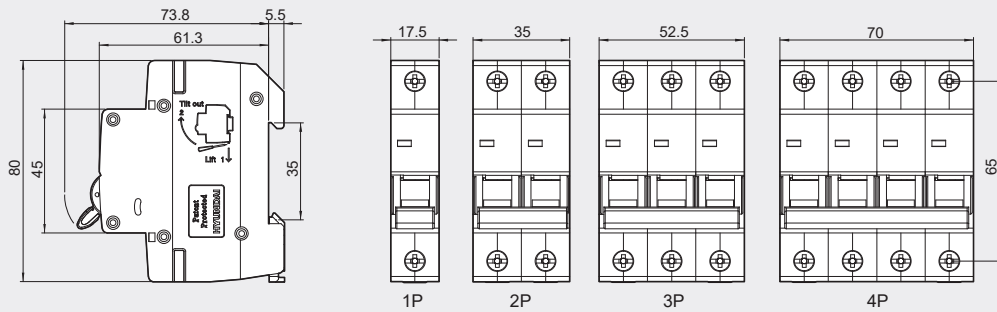

Rating	Code		Unit (EA)	HiBD63-S Category		
	B curve	C curve		MCB	M7	
  4.5kA, 1P	1A	HIBD63-S 1PMBS0000C 00001	HIBD63-S 1PMCS0000C 00001	120	MCB	M7
	2A	HIBD63-S 1PMBS0000C 00002	HIBD63-S 1PMCS0000C 00002			
	3A	HIBD63-S 1PMBS0000C 00003	HIBD63-S 1PMCS0000C 00003			
	4A	HIBD63-S 1PMBS0000C 00004	HIBD63-S 1PMCS0000C 00004			
	5A	HIBD63-S 1PMBS0000C 00005	HIBD63-S 1PMCS0000C 00005			
	6A	HIBD63-S 1PMBS0000C 00006	HIBD63-S 1PMCS0000C 00006			
	10A	HIBD63-S 1PMBS0000C 00010	HIBD63-S 1PMCS0000C 00010			
	13A	HIBD63-S 1PMBS0000C 00013	HIBD63-S 1PMCS0000C 00013			
	15A	HIBD63-S 1PMBS0000C 00015	HIBD63-S 1PMCS0000C 00015			
	16A	HIBD63-S 1PMBS0000C 00016	HIBD63-S 1PMCS0000C 00016			
	20A	HIBD63-S 1PMBS0000C 00020	HIBD63-S 1PMCS0000C 00020			
	25A	HIBD63-S 1PMBS0000C 00025	HIBD63-S 1PMCS0000C 00025			
	32A	HIBD63-S 1PMBS0000C 00032	HIBD63-S 1PMCS0000C 00032			
	40A	HIBD63-S 1PMBS0000C 00040	HIBD63-S 1PMCS0000C 00040			
  4.5kA, 2P	1A	HIBD63-S 2PMBS0000C 00001	HIBD63-S 2PMCS0000C 00001	60	MCB	M7
	2A	HIBD63-S 2PMBS0000C 00002	HIBD63-S 2PMCS0000C 00002			
	3A	HIBD63-S 2PMBS0000C 00003	HIBD63-S 2PMCS0000C 00003			
	4A	HIBD63-S 2PMBS0000C 00004	HIBD63-S 2PMCS0000C 00004			
	5A	HIBD63-S 2PMBS0000C 00005	HIBD63-S 2PMCS0000C 00005			
	6A	HIBD63-S 2PMBS0000C 00006	HIBD63-S 2PMCS0000C 00006			
	10A	HIBD63-S 2PMBS0000C 00010	HIBD63-S 2PMCS0000C 00010			
	13A	HIBD63-S 2PMBS0000C 00013	HIBD63-S 2PMCS0000C 00013			
	15A	HIBD63-S 2PMBS0000C 00015	HIBD63-S 2PMCS0000C 00015			
	16A	HIBD63-S 2PMBS0000C 00016	HIBD63-S 2PMCS0000C 00016			
	20A	HIBD63-S 2PMBS0000C 00020	HIBD63-S 2PMCS0000C 00020			
	25A	HIBD63-S 2PMBS0000C 00025	HIBD63-S 2PMCS0000C 00025			
	32A	HIBD63-S 2PMBS0000C 00032	HIBD63-S 2PMCS0000C 00032			
	40A	HIBD63-S 2PMBS0000C 00040	HIBD63-S 2PMCS0000C 00040			

Dimensions



Order information



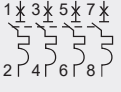

HiBD63-S

Rating	Code		Unit (EA)	Category	
	B curve	C curve			
  4,5kA, 3P	1A	HIBD63-S 3PMBS0000C 00001	HIBD63-S 3PMCS0000C 00001	40	MCB M7
	2A	HIBD63-S 3PMBS0000C 00002	HIBD63-S 3PMCS0000C 00002		
	3A	HIBD63-S 3PMBS0000C 00003	HIBD63-S 3PMCS0000C 00003		
	4A	HIBD63-S 3PMBS0000C 00004	HIBD63-S 3PMCS0000C 00004		
	5A	HIBD63-S 3PMBS0000C 00005	HIBD63-S 3PMCS0000C 00005		
	6A	HIBD63-S 3PMBS0000C 00006	HIBD63-S 3PMCS0000C 00006		
	10A	HIBD63-S 3PMBS0000C 00010	HIBD63-S 3PMCS0000C 00010		
	13A	HIBD63-S 3PMBS0000C 00013	HIBD63-S 3PMCS0000C 00013		
	15A	HIBD63-S 3PMBS0000C 00015	HIBD63-S 3PMCS0000C 00015		
	16A	HIBD63-S 3PMBS0000C 00016	HIBD63-S 3PMCS0000C 00016		
	20A	HIBD63-S 3PMBS0000C 00020	HIBD63-S 3PMCS0000C 00020		
	25A	HIBD63-S 3PMBS0000C 00025	HIBD63-S 3PMCS0000C 00025		
	32A	HIBD63-S 3PMBS0000C 00032	HIBD63-S 3PMCS0000C 00032		
40A	HIBD63-S 3PMBS0000C 00040	HIBD63-S 3PMCS0000C 00040			
  4,5kA, 4P	1A	HIBD63-S 4PMBS0000C 00001	HIBD63-S 4PMCS0000C 00001	30	MCB M7
	2A	HIBD63-S 4PMBS0000C 00002	HIBD63-S 4PMCS0000C 00002		
	3A	HIBD63-S 4PMBS0000C 00003	HIBD63-S 4PMCS0000C 00003		
	4A	HIBD63-S 4PMBS0000C 00004	HIBD63-S 4PMCS0000C 00004		
	5A	HIBD63-S 4PMBS0000C 00005	HIBD63-S 4PMCS0000C 00005		
	6A	HIBD63-S 4PMBS0000C 00006	HIBD63-S 4PMCS0000C 00006		
	10A	HIBD63-S 4PMBS0000C 00010	HIBD63-S 4PMCS0000C 00010		
	13A	HIBD63-S 4PMBS0000C 00013	HIBD63-S 4PMCS0000C 00013		
	15A	HIBD63-S 4PMBS0000C 00015	HIBD63-S 4PMCS0000C 00015		
	16A	HIBD63-S 4PMBS0000C 00016	HIBD63-S 4PMCS0000C 00016		
	20A	HIBD63-S 4PMBS0000C 00020	HIBD63-S 4PMCS0000C 00020		
	25A	HIBD63-S 4PMBS0000C 00025	HIBD63-S 4PMCS0000C 00025		
	32A	HIBD63-S 4PMBS0000C 00032	HIBD63-S 4PMCS0000C 00032		
40A	HIBD63-S 4PMBS0000C 00040	HIBD63-S 4PMCS0000C 00040			

HiBD63-E / 3kA 1-40A

Standard Protection Specification	IEC/EN60898 overload, short-circuit 3kA at AC240/415V - AC240V (1P), AC240/415V - Ics = 100% Icu 1, 2, 3, 4, 5, 6, 10, 13, 15, 16, 20, 25, 32, 40A 1, 2, 3, 4 pole B, C curve
Accessory	auxiliary switch, trip alarm switch, auxiliary & trip alarm switch, shunt trip, shunt trip & auxiliary switch, under voltage trip

■ Order information

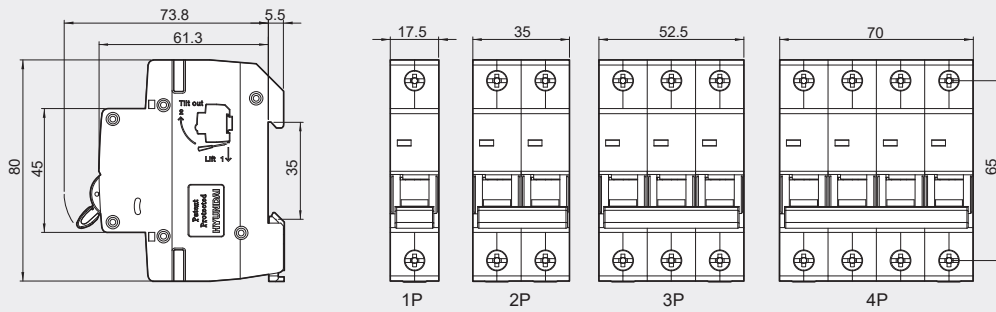

Rating	Code		Unit (EA)	HiBD63-E Category		
	B curve	C curve		MCB	M7	
  3kA, 1P	1A	HIBD63-E 1PMBS0000C 00001	HIBD63-E 1PMCS0000C 00001	120	MCB	M7
	2A	HIBD63-E 1PMBS0000C 00002	HIBD63-E 1PMCS0000C 00002			
	3A	HIBD63-E 1PMBS0000C 00003	HIBD63-E 1PMCS0000C 00003			
	4A	HIBD63-E 1PMBS0000C 00004	HIBD63-E 1PMCS0000C 00004			
	5A	HIBD63-E 1PMBS0000C 00005	HIBD63-E 1PMCS0000C 00005			
	6A	HIBD63-E 1PMBS0000C 00006	HIBD63-E 1PMCS0000C 00006			
	10A	HIBD63-E 1PMBS0000C 00010	HIBD63-E 1PMCS0000C 00010			
	13A	HIBD63-E 1PMBS0000C 00013	HIBD63-E 1PMCS0000C 00013			
	15A	HIBD63-E 1PMBS0000C 00015	HIBD63-E 1PMCS0000C 00015			
	16A	HIBD63-E 1PMBS0000C 00016	HIBD63-E 1PMCS0000C 00016			
	20A	HIBD63-E 1PMBS0000C 00020	HIBD63-E 1PMCS0000C 00020			
	25A	HIBD63-E 1PMBS0000C 00025	HIBD63-E 1PMCS0000C 00025			
	32A	HIBD63-E 1PMBS0000C 00032	HIBD63-E 1PMCS0000C 00032			
	40A	HIBD63-E 1PMBS0000C 00040	HIBD63-E 1PMCS0000C 00040			
  3kA, 2P	1A	HIBD63-E 2PMBS0000C 00001	HIBD63-E 2PMCS0000C 00001	60	MCB	M7
	2A	HIBD63-E 2PMBS0000C 00002	HIBD63-E 2PMCS0000C 00002			
	3A	HIBD63-E 2PMBS0000C 00003	HIBD63-E 2PMCS0000C 00003			
	4A	HIBD63-E 2PMBS0000C 00004	HIBD63-E 2PMCS0000C 00004			
	5A	HIBD63-E 2PMBS0000C 00005	HIBD63-E 2PMCS0000C 00005			
	6A	HIBD63-E 2PMBS0000C 00006	HIBD63-E 2PMCS0000C 00006			
	10A	HIBD63-E 2PMBS0000C 00010	HIBD63-E 2PMCS0000C 00010			
	13A	HIBD63-E 2PMBS0000C 00013	HIBD63-E 2PMCS0000C 00013			
	15A	HIBD63-E 2PMBS0000C 00015	HIBD63-E 2PMCS0000C 00015			
	16A	HIBD63-E 2PMBS0000C 00016	HIBD63-E 2PMCS0000C 00016			
	20A	HIBD63-E 2PMBS0000C 00020	HIBD63-E 2PMCS0000C 00020			
	25A	HIBD63-E 2PMBS0000C 00025	HIBD63-E 2PMCS0000C 00025			
	32A	HIBD63-E 2PMBS0000C 00032	HIBD63-E 2PMCS0000C 00032			
	40A	HIBD63-E 2PMBS0000C 00040	HIBD63-E 2PMCS0000C 00040			

Dimensions

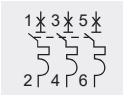

Order information

HiBD63-E

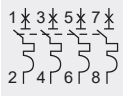
Rating	Code		Unit (EA)	Category						
	B curve	C curve		MCB	M7					
  3kA, 3P	1A	HIBD63-E 3PMBS0000C 00001	HIBD63-E 3PMCS0000C 00001	40	MCB	M7				
	2A	HIBD63-E 3PMBS0000C 00002	HIBD63-E 3PMCS0000C 00002							
	3A	HIBD63-E 3PMBS0000C 00003	HIBD63-E 3PMCS0000C 00003							
	4A	HIBD63-E 3PMBS0000C 00004	HIBD63-E 3PMCS0000C 00004							
	5A	HIBD63-E 3PMBS0000C 00005	HIBD63-E 3PMCS0000C 00005							
	6A	HIBD63-E 3PMBS0000C 00006	HIBD63-E 3PMCS0000C 00006							
	10A	HIBD63-E 3PMBS0000C 00010	HIBD63-E 3PMCS0000C 00010							
	13A	HIBD63-E 3PMBS0000C 00013	HIBD63-E 3PMCS0000C 00013							
	15A	HIBD63-E 3PMBS0000C 00015	HIBD63-E 3PMCS0000C 00015							
	16A	HIBD63-E 3PMBS0000C 00016	HIBD63-E 3PMCS0000C 00016							
	20A	HIBD63-E 3PMBS0000C 00020	HIBD63-E 3PMCS0000C 00020							
	25A	HIBD63-E 3PMBS0000C 00025	HIBD63-E 3PMCS0000C 00025							
	32A	HIBD63-E 3PMBS0000C 00032	HIBD63-E 3PMCS0000C 00032							
	40A	HIBD63-E 3PMBS0000C 00040	HIBD63-E 3PMCS0000C 00040							
	  3kA, 4P	1A	HIBD63-E 4PMBS0000C 00001				HIBD63-E 4PMCS0000C 00001	30	MCB	M7
		2A	HIBD63-E 4PMBS0000C 00002				HIBD63-E 4PMCS0000C 00002			
3A		HIBD63-E 4PMBS0000C 00003	HIBD63-E 4PMCS0000C 00003							
4A		HIBD63-E 4PMBS0000C 00004	HIBD63-E 4PMCS0000C 00004							
5A		HIBD63-E 4PMBS0000C 00005	HIBD63-E 4PMCS0000C 00005							
6A		HIBD63-E 4PMBS0000C 00006	HIBD63-E 4PMCS0000C 00006							
10A		HIBD63-E 4PMBS0000C 00010	HIBD63-E 4PMCS0000C 00010							
13A		HIBD63-E 4PMBS0000C 00013	HIBD63-E 4PMCS0000C 00013							
15A		HIBD63-E 4PMBS0000C 00015	HIBD63-E 4PMCS0000C 00015							
16A		HIBD63-E 4PMBS0000C 00016	HIBD63-E 4PMCS0000C 00016							
20A		HIBD63-E 4PMBS0000C 00020	HIBD63-E 4PMCS0000C 00020							
25A		HIBD63-E 4PMBS0000C 00025	HIBD63-E 4PMCS0000C 00025							
32A		HIBD63-E 4PMBS0000C 00032	HIBD63-E 4PMCS0000C 00032							
40A		HIBD63-E 4PMBS0000C 00040	HIBD63-E 4PMCS0000C 00040							